

ESDL2012

ESD Protection Diode

Micro-Packaged Diodes for ESD Protection

The ESDL2012 is designed to protect voltage sensitive components that require low capacitance from ESD and transient voltage events. Excellent clamping capability, low capacitance, low leakage, and fast response time, make these parts ideal for ESD protection on designs where board space is at a premium. Because of its low capacitance, the part is well suited for use in high speed data line applications.

Features

- Low Capacitance
- Low Clamping Voltage
- Small Body Outline Dimensions: 0.60 mm x 0.30 mm
- Low Body Height: 0.2 mm
- Stand-off Voltage: 1.0 V
- IEC61000-4-2 Level 4 ESD Protection
- SZ Prefix for Automotive and Other Applications Requiring Unique Site and Control Change Requirements; AEC-Q101 Qualified and PPAP Capable
- SZESDL2012MX2WT5G – Wettable Flank Package for optimal Automated Optical Inspection (AOI)
- These Devices are Pb-Free, Halogen Free/BFR Free and are RoHS Compliant

Typical Applications

- USB 3.x
- Thunderbolt 3.0

MAXIMUM RATINGS

Rating	Symbol	Value	Unit
IEC 61000-4-2 (ESD) Contact Air		±16 ±16	kV
Total Power Dissipation on FR-4 Board (Note 1) @ T _A = 25°C	P _D	313	mW
Thermal Resistance, Junction-to-Ambient	R _{θJA}	400	°C/W
Junction and Storage Temperature Range	T _J , T _{stg}	-55 to +150	°C
Lead Solder Temperature – Maximum (10 Second Duration)	T _L	260	°C

Stresses exceeding those listed in the Maximum Ratings table may damage the device. If any of these limits are exceeded, device functionality should not be assumed, damage may occur and reliability may be affected.

1. FR-4 = 28 mm² 1 oz. Cu JEDEC JESD51-3 two layer PCB.

See Application Note AND8308/D for further description of survivability specs.



ON Semiconductor®

www.onsemi.com



**X4DFN2
(0201)
CASE 152AX**

MARKING DIAGRAM



K = Specific Device Code
M = Date Code



**X2DFNW2
CASE 717AB**



XX = Specific Device Code
M = Date Code

ORDERING INFORMATION

Device	Package	Shipping†
ESDL2012MX4T5G	X4DFN2 (Pb-Free)	10000 / Tape & Reel
SZESDL2012MX2WT5G (In Development)	X2DFNW2 (Pb-Free)	8000 / Tape & Reel

†For information on tape and reel specifications, including part orientation and tape sizes, please refer to our Tape and Reel Packaging Specifications Brochure, BRD8011/D.

ELECTRICAL CHARACTERISTICS

(T_A = 25°C unless otherwise noted)

Symbol	Parameter
I _{PP}	Maximum Reverse Peak Pulse Current
V _C	Clamping Voltage @ I _{PP}
V _{RWM}	Working Peak Reverse Voltage
I _R	Maximum Reverse Leakage Current @ V _{RWM}
V _{BR}	Breakdown Voltage @ I _T
I _T	Test Current

*See Application Note AND8308/D for detailed explanations of datasheet parameters.

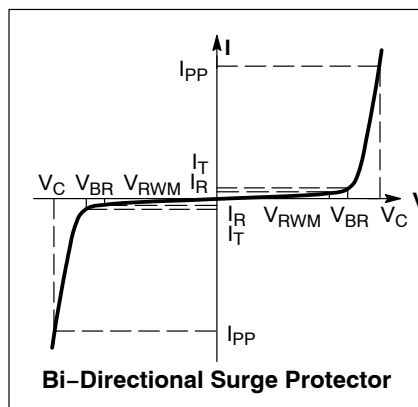

ELECTRICAL CHARACTERISTICS (T_A = 25°C unless otherwise specified)

Parameter	Symbol	Conditions	Min	Typ	Max	Unit
Reverse Working Voltage	V _{RWM}	I/O Pin to GND			1.0	V
Breakdown Voltage	V _{BR}	I _T = 1 mA, I/O Pin to GND	1.4	1.6	2.1	V
Reverse Leakage Current	I _R	V _{RWM} = 1.0 V		30	500	nA
Clamping Voltage (Note 2)	V _C	IEC61000-4-2, ±8 kV Contact	Figures 1 and 2			V
Clamping Voltage, 200 ns TLP, IEC61000-4-2 Level 1 Equivalent (±2 kV Contact, ±4 kV Air)	V _C	I _{PP} = 4 A		3.5	4.0	V
		I _{PP} = 4 A (SZESDL2012)			5.0	
IEC61000-4-2 Level 2 Equivalent (±4 kV Contact, ±8 kV Air)	V _C	I _{PP} = 8 A		4.7	5.2	V
		I _{PP} = 8 A (SZESDL2012)			7.5	
Reverse Peak Pulse Current per Figure 12	I _{PP}	per IEC61000-4-5 (1.2/50 μs), R _{eq} = 12 Ω	3.5	4.7		A
Clamping Voltage, IEC61000-4-5 (1.2/50 μs) Waveform per Figure 12	V _C	I _{PP} = 2.1 A, R _{eq} = 12 Ω		3.1	3.4	V
		I _{PP} = 2.1 A, R _{eq} = 12 Ω (SZESDL2012)			4.5	
Clamping Voltage, IEC61000-4-5 (1.2/50 μs) Waveform per Figure 12	V _C	I _{PP} = 3.5 A, R _{eq} = 12 Ω		3.7	4.1	V
		I _{PP} = 3.5 A, R _{eq} = 12 Ω (SZESDL2012)			5.5	
Dynamic Resistance (200 ns TLP, 4 A to 8 A)	R _{DYN}	I/O Pin to GND I/O Pin to GND (SZESDL2012)		0.30 0.65		Ω
Junction Capacitance	C _J	V _R = 0 V, f = 1 MHz V _R = 0 V, f = 1 MHz (SZESDL2012)		0.18 0.25	0.23 0.35	pF
Insertion Loss	I _L	f = 10 GHz		0.26	0.33	dB
		f = 13 GHz		0.27	0.36	
		f = 15 GHz		0.28	0.37	
Return Loss	R _L	f = 10 GHz	14	16		dB
		f = 13 GHz	12	14		
		f = 15 GHz	11	13		

Product parametric performance is indicated in the Electrical Characteristics for the listed test conditions, unless otherwise noted. Product performance may not be indicated by the Electrical Characteristics if operated under different conditions.

- For test procedure see application note AND8307/D.
- ANSI/ESD STM5.5.1 – Electrostatic Discharge Sensitivity Testing using Transmission Line Pulse (TLP) Model.
TLP conditions: Z₀ = 50 Ω, t_p = 200 ns, t_r = 1 ns, averaging window; t₁ = 170 ns to t₂ = 190 ns.

TYPICAL CHARACTERISTICS

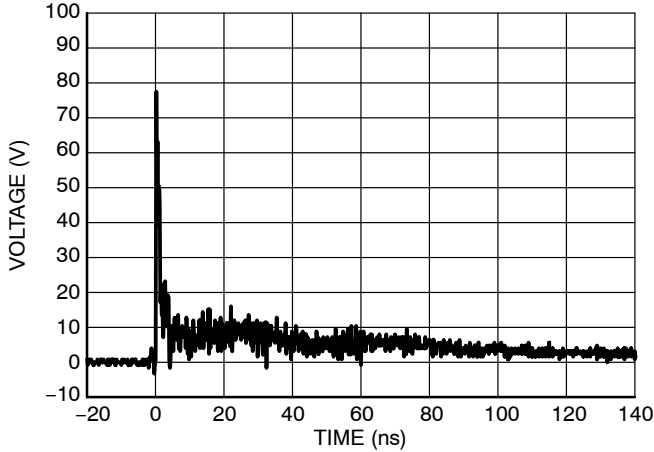

Figure 1. ESD Clamping Voltage
Positive 8 kV Contact per IEC61000-4-2

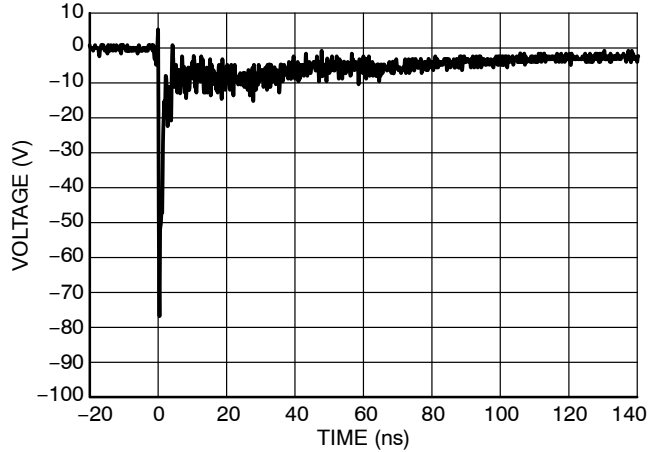

Figure 2. ESD Clamping Voltage
Negative 8 kV Contact per IEC61000-4-2

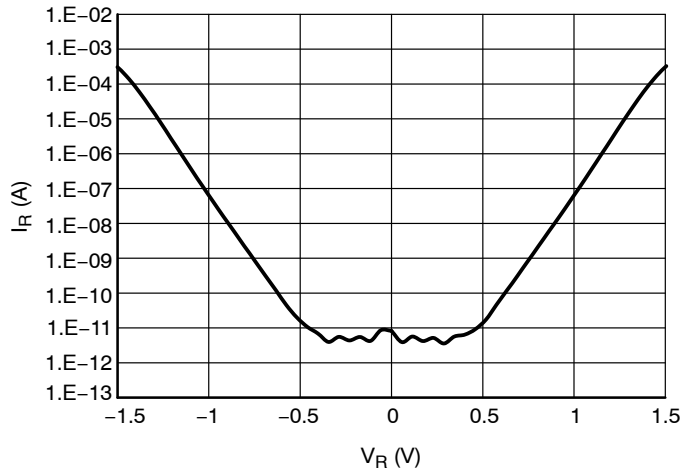

Figure 3. IV Characteristics

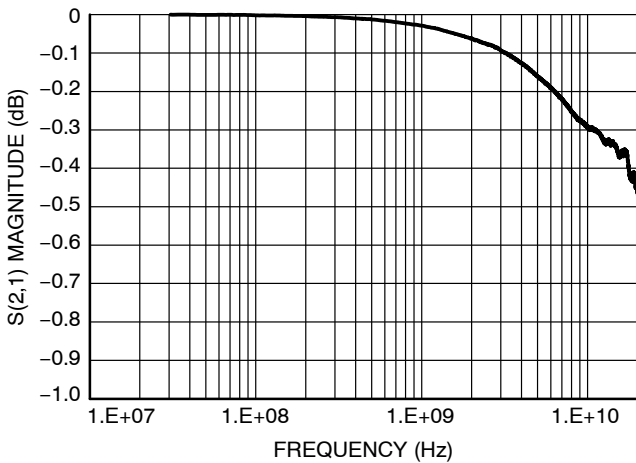

Figure 4. Insertion Loss

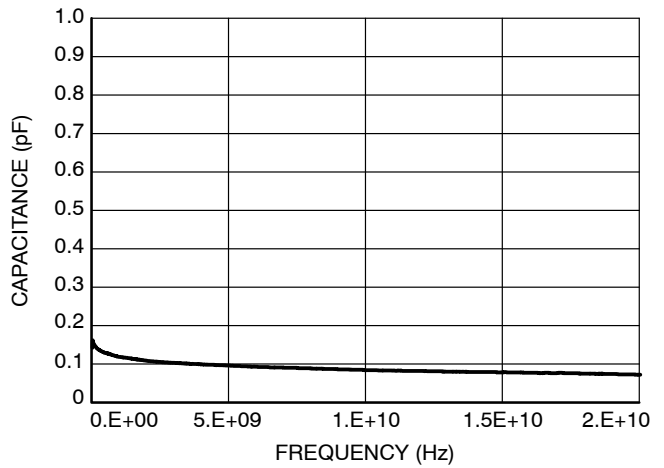

Figure 5. Capacitance Over Frequency

TYPICAL CHARACTERISTICS

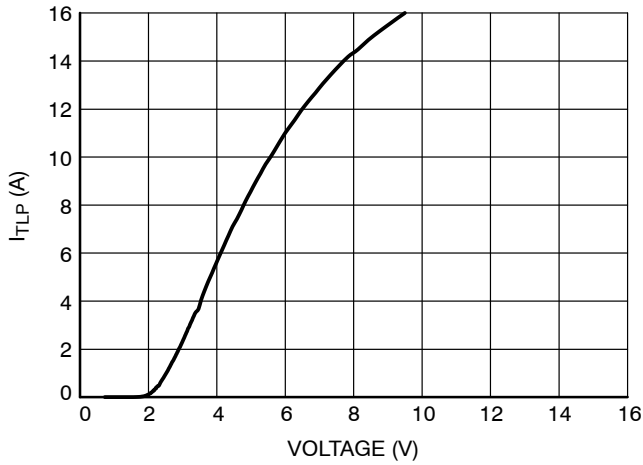

Figure 6. Positive 200 ns TLP IV Curve

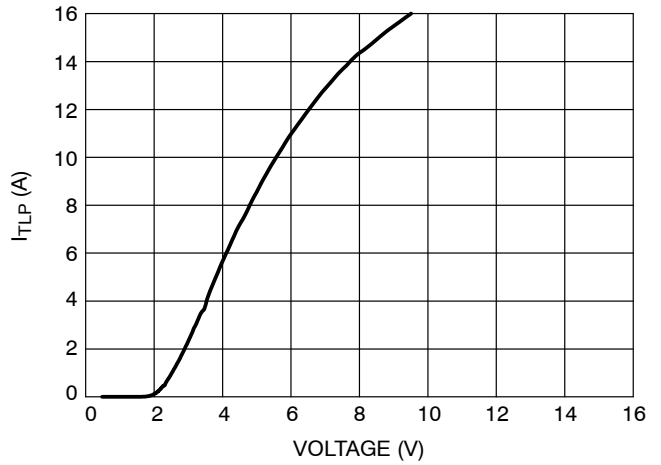

Figure 7. Negative 200 ns TLP IV Curve

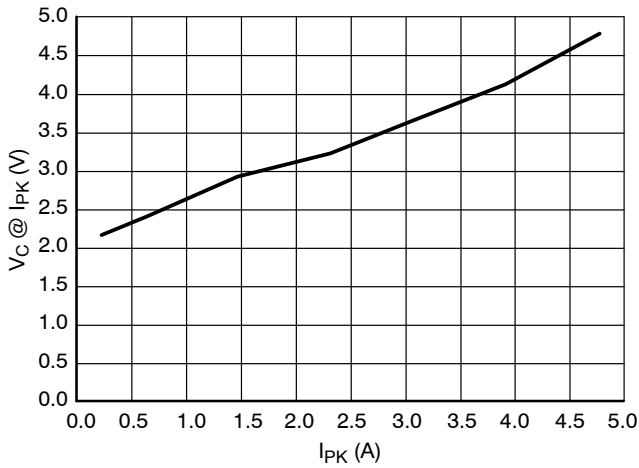

Figure 8. Positive Clamping Voltage vs. Peak Pulse Current (per IEC61000-4-5 ($t_p = 1.2/50 \mu s$, $R_{eq} = 12 \Omega$))

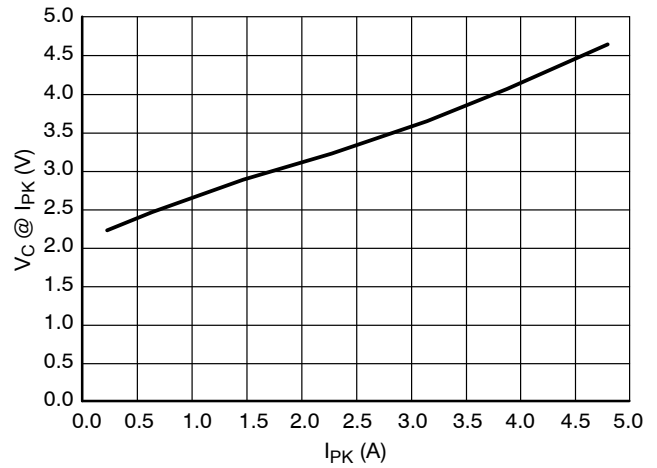

Figure 9. Negative Clamping Voltage vs. Peak Pulse Current (per IEC61000-4-5 ($t_p = 1.2/50 \mu s$, $R_{eq} = 12 \Omega$))

IEC 61000-4-2 Spec.

Level	Test Voltage (kV)	First Peak Current (A)	Current at 30 ns (A)	Current at 60 ns (A)
1	2	7.5	4	2
2	4	15	8	4
3	6	22.5	12	6
4	8	30	16	8

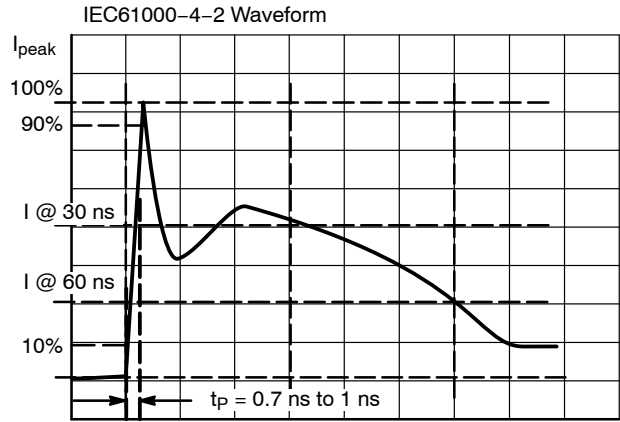

Figure 10. IEC61000-4-2 Spec

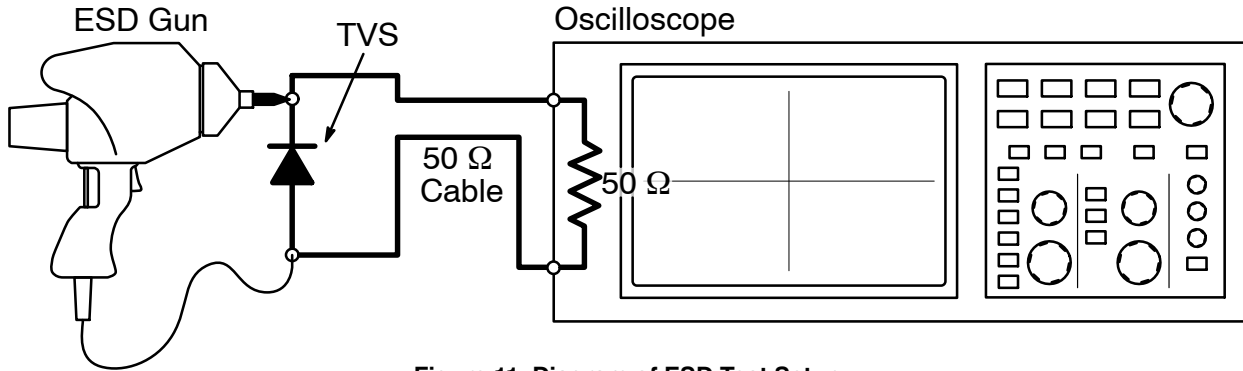

Figure 11. Diagram of ESD Test Setup

ESD Voltage Clamping

For sensitive circuit elements it is important to limit the voltage that an IC will be exposed to during an ESD event to as low a voltage as possible. The ESD clamping voltage is the voltage drop across the ESD protection diode during an ESD event per the IEC61000-4-2 waveform. Since the IEC61000-4-2 was written as a pass/fail spec for larger systems such as cell phones or laptop computers it is not clearly defined in the spec how to specify a clamping voltage

at the device level. ON Semiconductor has developed a way to examine the entire voltage waveform across the ESD protection diode over the time domain of an ESD pulse in the form of an oscilloscope screenshot, which can be found on the datasheets for all ESD protection diodes. For more information on how ON Semiconductor creates these screenshots and how to interpret them please refer to AND8307/D.

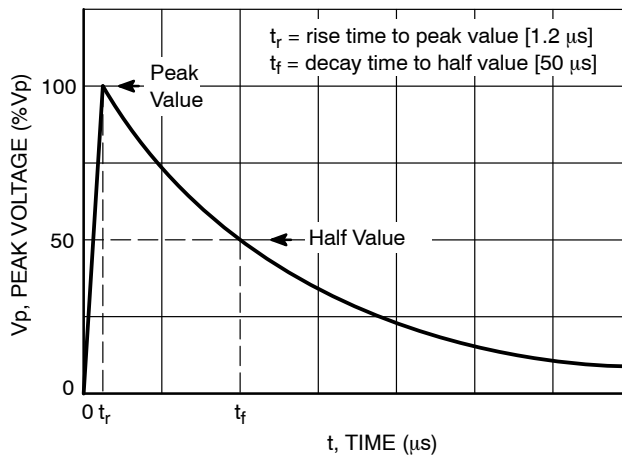
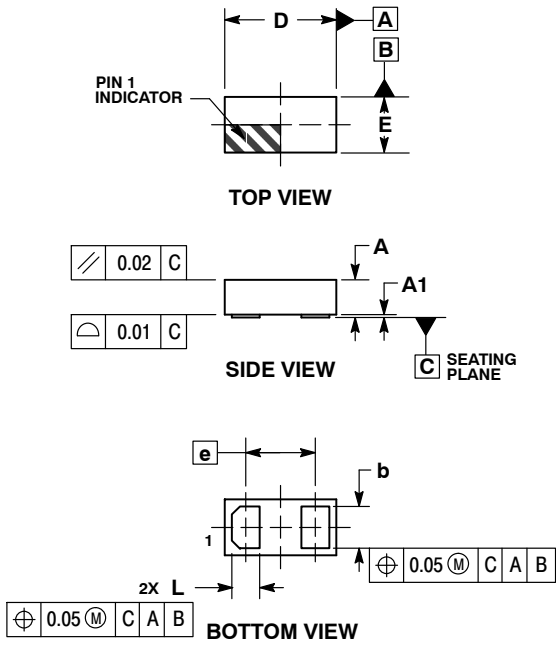

Figure 12. IEC61000-4-5 1.2/50 µs Pulse Waveform

ESDL2012

PACKAGE DIMENSIONS

DFN2, 0.60x0.30, 0.36P
CASE 152AX
ISSUE F



NOTES:

1. DIMENSIONING AND TOLERANCING PER ASME Y14.5M, 1994.
2. CONTROLLING DIMENSION: MILLIMETERS.

MILLIMETERS			
DIM	MIN	NOM	MAX
A	0.175	0.200	0.225
A1	0.018 REF		
b	0.205	0.215	0.225
D	0.575	0.600	0.625
E	0.275	0.300	0.325
e	0.36 BSC		
L	0.145	0.155	0.165

**RECOMMENDED
SOLDER FOOTPRINT***

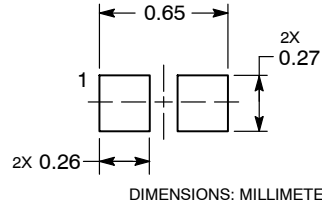

*For additional information on our Pb-Free strategy and soldering details, please download the ON Semiconductor Soldering and Mounting Techniques Reference Manual, SOLDERRM/D.

ESDL2012

PACKAGE DIMENSIONS

X2DFNW2 1.60x0.80
CASE 717AB
ISSUE B

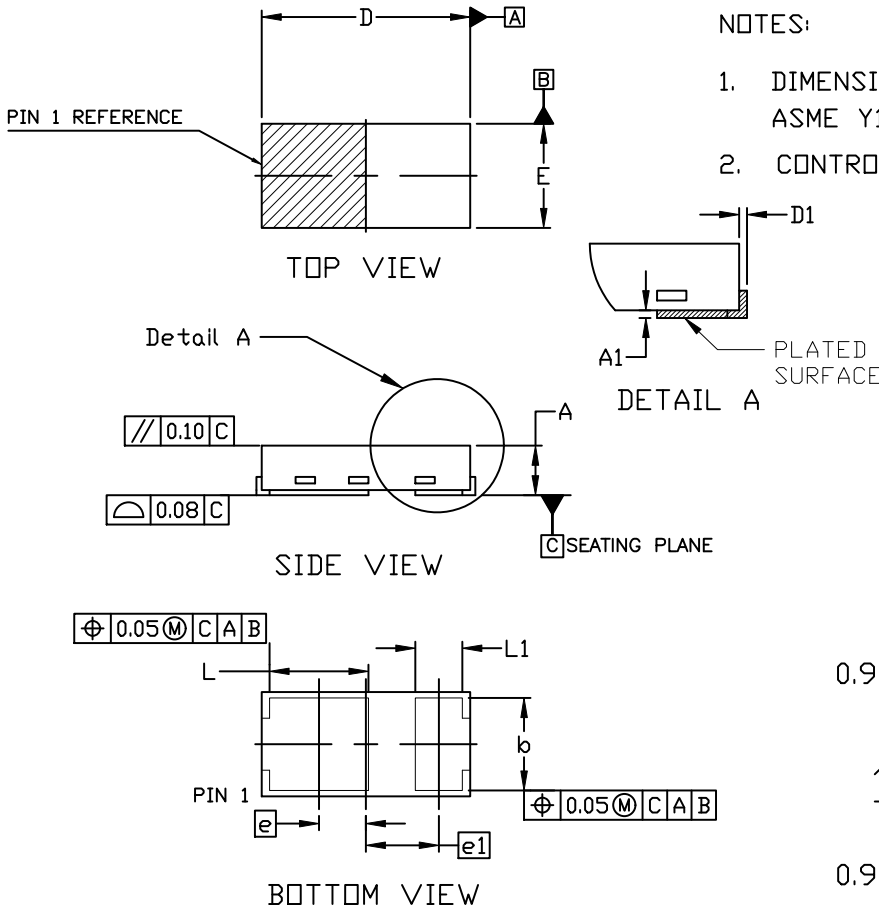

NOTES:

1. DIMENSIONING AND TOLERANCING PER ASME Y14.5M, 2009.
2. CONTROLLING DIMENSION: MILLIMETERS

DIM	MILLIMETERS		
	MIN.	NOM.	MAX.
A	0.34	0.37	0.40
A1	---	---	0.04
b	0.67	0.71	0.75
D	1.55	1.60	1.65
D1	---	---	0.04
E	0.75	0.80	0.85
e	0.36 BSC		
e1	0.56 BSC		
L	0.72	0.76	0.80
L1	0.32	0.36	0.40

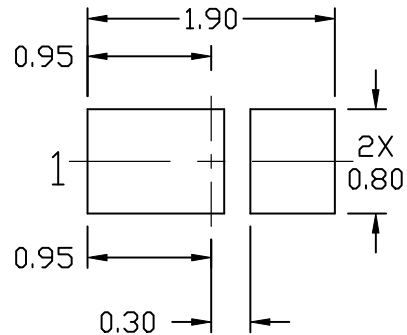

RECOMMENDED MOUNTING FOOTPRINT*

* For additional information on our Pb-Free strategy and soldering details, please download the ON Semiconductor Soldering and Mounting Techniques Reference Manual, SOLDERRM/D.

ON Semiconductor and are trademarks of Semiconductor Components Industries, LLC dba ON Semiconductor or its subsidiaries in the United States and/or other countries. ON Semiconductor owns the rights to a number of patents, trademarks, copyrights, trade secrets, and other intellectual property. A listing of ON Semiconductor's product/patent coverage may be accessed at www.onsemi.com/site/pdf/Patent-Marking.pdf. ON Semiconductor reserves the right to make changes without further notice to any products herein. ON Semiconductor makes no warranty, representation or guarantee regarding the suitability of its products for any particular purpose, nor does ON Semiconductor assume any liability arising out of the application or use of any product or circuit, and specifically disclaims any and all liability, including without limitation special, consequential or incidental damages. Buyer is responsible for its products and applications using ON Semiconductor products, including compliance with all laws, regulations and safety requirements or standards, regardless of any support or applications information provided by ON Semiconductor. "Typical" parameters which may be provided in ON Semiconductor data sheets and/or specifications can and do vary in different applications and actual performance may vary over time. All operating parameters, including "Typicals" must be validated for each customer application by customer's technical experts. ON Semiconductor does not convey any license under its patent rights nor the rights of others. ON Semiconductor products are not designed, intended, or authorized for use as a critical component in life support systems or any FDA Class 3 medical devices or medical devices with a same or similar classification in a foreign jurisdiction or any devices intended for implantation in the human body. Should Buyer purchase or use ON Semiconductor products for any such unintended or unauthorized application, Buyer shall indemnify and hold ON Semiconductor and its officers, employees, subsidiaries, affiliates, and distributors harmless against all claims, costs, damages, and expenses, and reasonable attorney fees arising out of, directly or indirectly, any claim of personal injury or death associated with such unintended or unauthorized use, even if such claim alleges that ON Semiconductor was negligent regarding the design or manufacture of the part. ON Semiconductor is an Equal Opportunity/Affirmative Action Employer. This literature is subject to all applicable copyright laws and is not for resale in any manner.

PUBLICATION ORDERING INFORMATION

LITERATURE FULFILLMENT:

Literature Distribution Center for ON Semiconductor
P.O. Box 5163, Denver, Colorado 80217 USA
Phone: 303-675-2175 or 800-344-3860 Toll Free USA/Canada
Fax: 303-675-2176 or 800-344-3867 Toll Free USA/Canada
Email: orderlit@onsemi.com

N. American Technical Support: 800-282-9855 Toll Free
USA/Canada
Europe, Middle East and Africa Technical Support:
Phone: 421 33 790 2910

ON Semiconductor Website: www.onsemi.com

Order Literature: <http://www.onsemi.com/orderlit>

For additional information, please contact your local Sales Representative

Mouser Electronics

Authorized Distributor

Click to View Pricing, Inventory, Delivery & Lifecycle Information:

[ON Semiconductor:](#)

[ESDL2012MX4T5G](#)