

- 1 orange/blanc +5V_TFT
- 2 orange 5V
- 3 vert/blanc AU1
- 4 bleu AU2
- 5 bleu/blanc GND TFT
- 6 vert TX KSAP6
- 7 marron/blanc RX KSAP6
- 8 marron GND

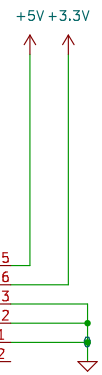
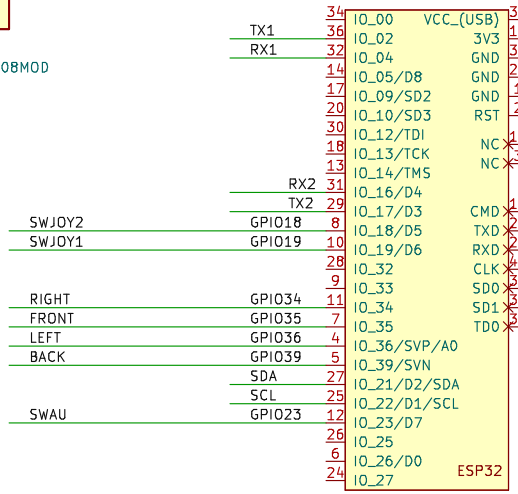
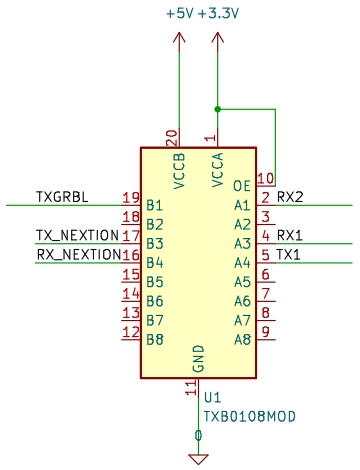
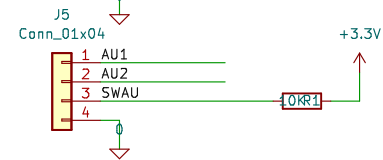
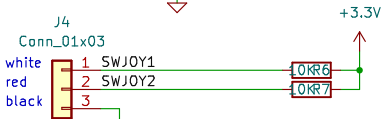
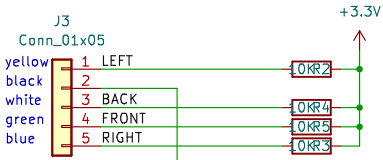
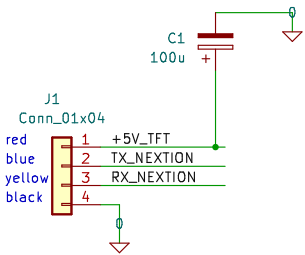

LAAS-CNRS F.BLANC

Sheet: /
File: conKSAP6.kicad_sch

Title: KONKSAP6

Size: A4 Date: 2023-03-13
KiCad E.D.A. eeschema 7.0.7-7.0.7-ubuntu20.04.1

Rev: 1.1
Id: 1/1